

### ADVANTAGES OF COVERS/HOODS MBS Group

MBS	OTHER MANUFACTURERS
<b>RIGIDITY FOLD</b> GREATER RIGIDITY OF THE COVER / HOOD AVOID CUTS DURING ITS MANIPULATION	
<b>ROUNDED CORNER</b> AVOID CUTS DURING ITS MANIPULATION	

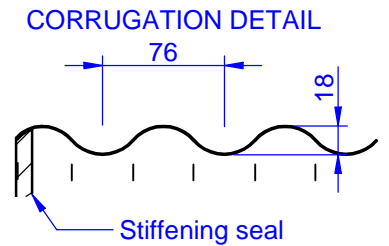

Sheet thickness 0.6mm and 1.2mm. in edges.



NOT SPECIFIED TOLERANCE

DIMENSIONS		ANGLES	
( )	: ±2.00	0°	: ±02' 00"
X.	: ±0.50		
X.0	: ±0.25	0° 0'	: ±00' 30"
X.00	: ±0.08		
X.000	: ±0.02	0° 0' 0"	: ±00' 03"

CAD DRAWING. HANDLING ON CAD SYSTEM ONLY

THIS DRAWING IS OWNED BY MBS.  
COPY OR REPRODUCTION IS FORBIDDEN  
WITHOUT PREVIOUS NOTICE

SCALE	DESIGNED	DRAWN	CHECKED	SHEET 1 OF 4	FORMAT
DATE			NOV-09	NAME	EUR
SIGNATURE	P.GLEZ		J.SAURA		
NAME	PARIS CLASSIC COVER (GENERAL VIEW)			DRAWING NUMBER	
				CAD FILE	
				PARIS CLASSIC COVER MBS.dft	

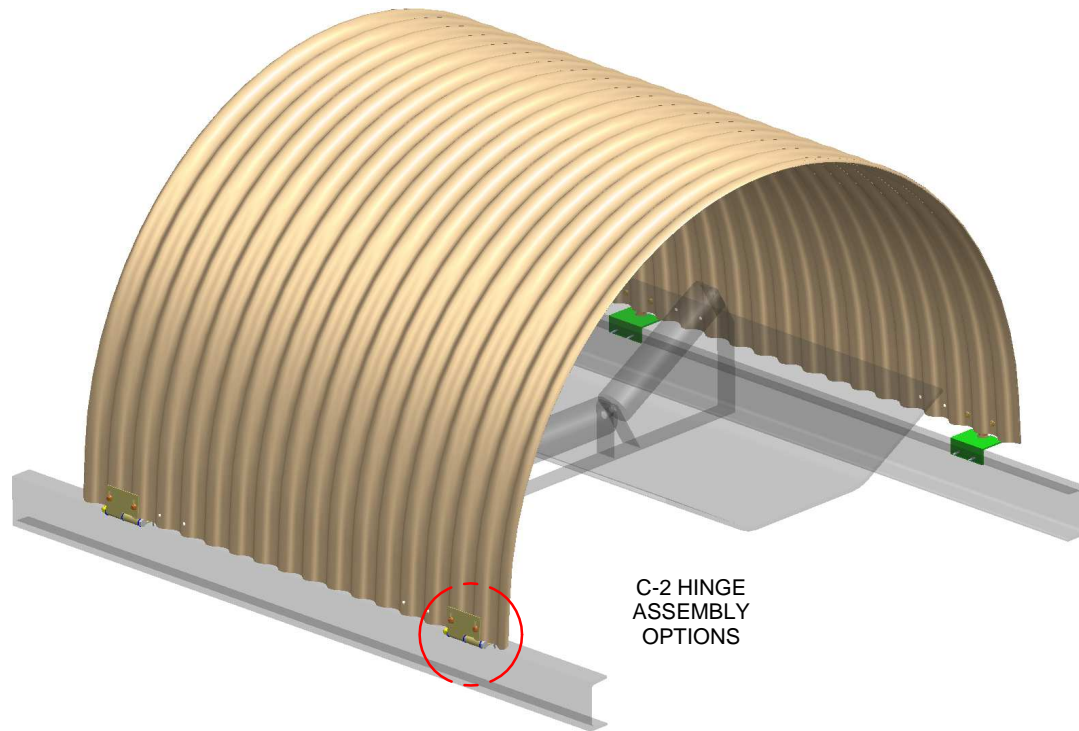

C-2 HINGE ASSEMBLY OPTIONS

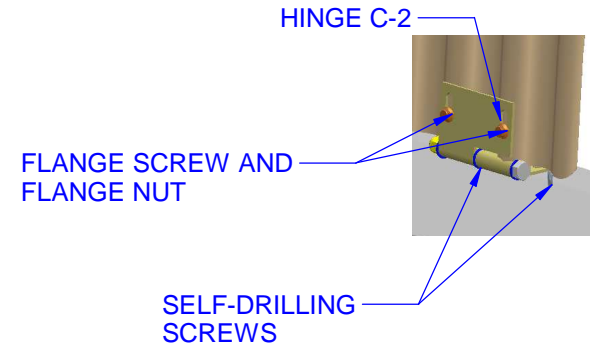

**OPTION 1**

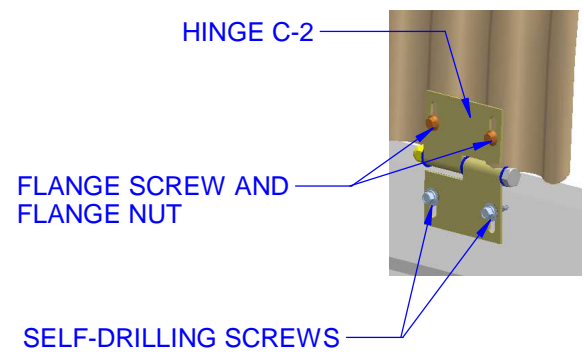

**OPTION 2**



NOT SPECIFIED TOLERANCE			
DIMENSIONS		ANGLES	
( )	: ±2.00	0°	: ±02' 00"
X.	: ±0.50		
X.0	: ±0.25	0° 0'	: ±00' 30"
X.00	: ±0.08		
X.000	: ±0.02	0° 0' 0"	: ±00' 03"

CAD DRAWING. HANDLING ON CAD SYSTEM ONLY

THIS DRAWING IS OWNED BY MBS.  
COPY OR REPRODUCTION IS FORBIDDEN  
WITHOUT PREVIOUS NOTICE

SCALE	DESIGNED	DRAWN	CHECKED	SHEET 2 OF 4	FORMAT
DATE	.	.	NOV-09	NAME	EUR
SIGNATURE	P.GLEZ	.	J.SAURA		A3

NAME  
**PARIS CLASSIC COVER  
(GENERAL VIEW)**

DRAWING NUMBER  
.  
CAD FILE  
PARIS CLASSIC COVER MBS.dft

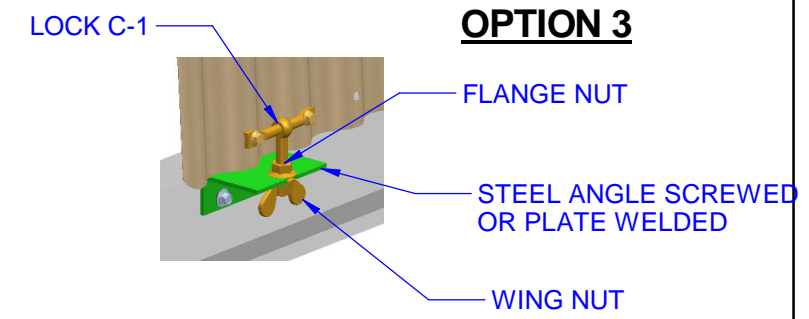
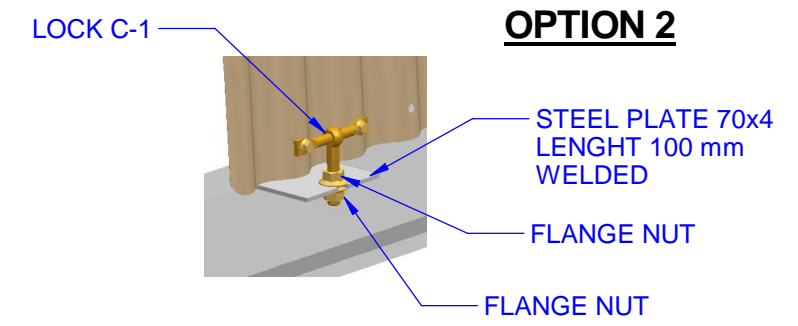
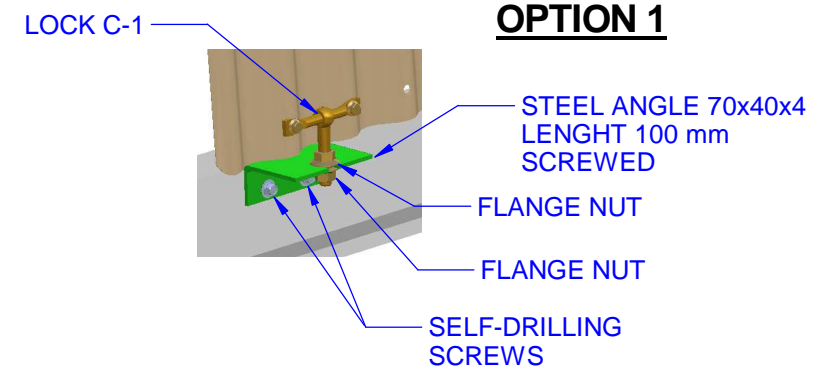
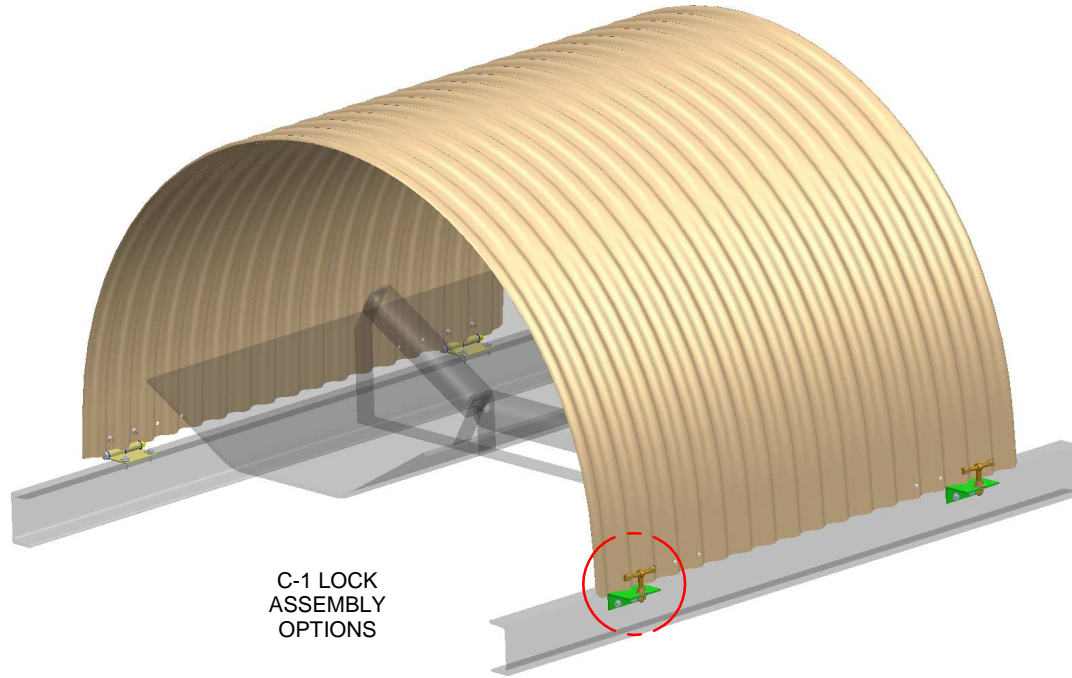

NOT SPECIFIED TOLERANCE

DIMENSIONS		ANGLES	
( )	: ±2.00	0°	: ±02' 00"
X.	: ±0.50		
X.0	: ±0.25	0° 0'	: ±00' 30"
X.00	: ±0.08		
X.000	: ±0.02	0° 0' 0"	: ±00' 03"

CAD DRAWING. HANDLING ON CAD SYSTEM ONLY

THIS DRAWING IS OWNED BY MBS.  
COPY OR REPRODUCTION IS FORBIDDEN  
WITHOUT PREVIOUS NOTICE

SCALE	DESIGNED	DRAWN	CHECKED	SHEET 3 OF 4	FORMAT
DATE	.	.	NOV-09	NAME	EUR
SIGNATURE	P.GLEZ	.	J.SAURA	FORM	A3
NAME	PARIS CLASSIC COVER (GENERAL VIEW)			DRAWING NUMBER	
				CAD FILE	
				PARIS CLASSIC COVER MBS.dft	

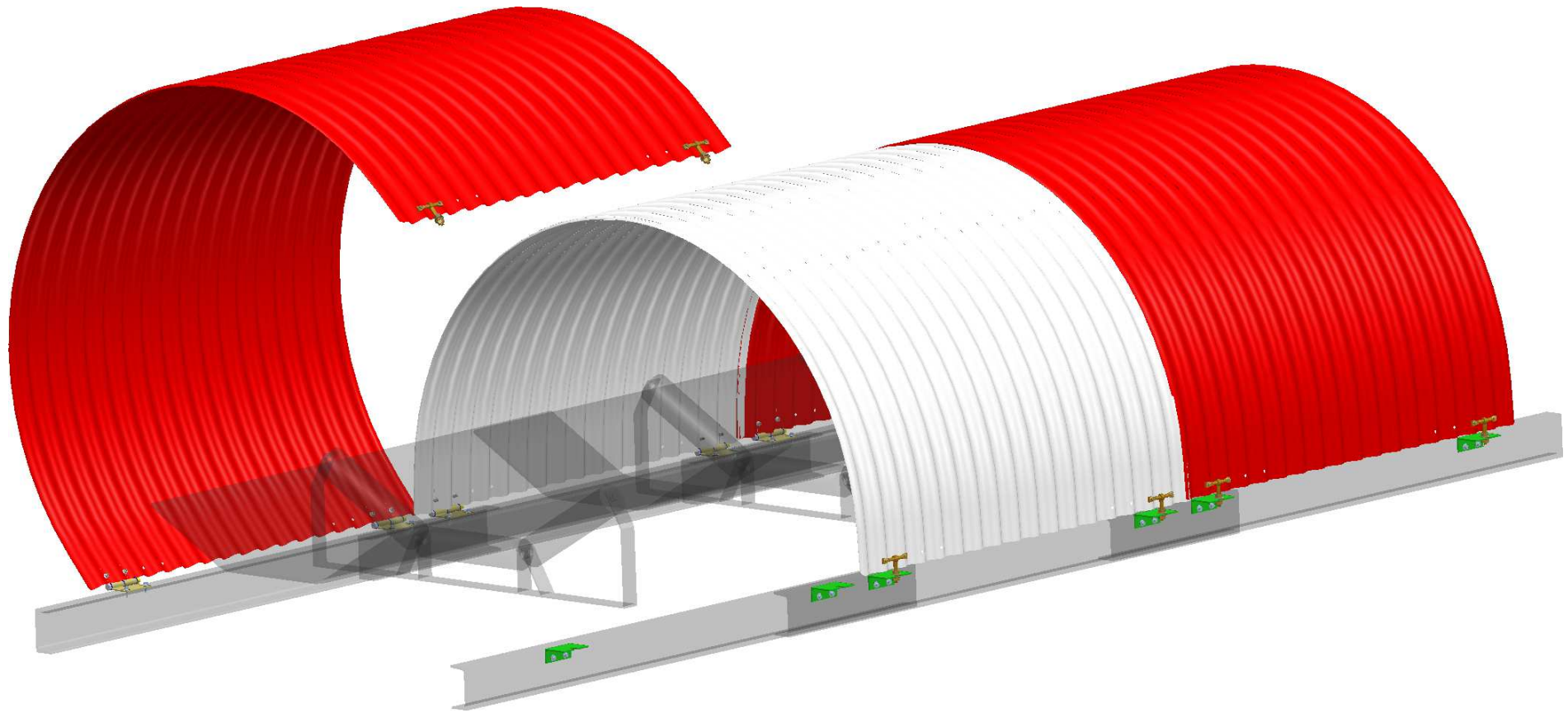

**INSTALLATION EXAMPLE**



NOT SPECIFIED TOLERANCE			
DIMENSIONS		ANGLES	
( )	: ±2.00	0°	: ±02' 00"
X.	: ±0.50		
X.0	: ±0.25	0° 0'	: ±00' 30"
X.00	: ±0.08		
X.000	: ±0.02	0° 0' 0"	: ±00' 03"

**CAD DRAWING. HANDLING ON CAD SYSTEM ONLY**

THIS DRAWING IS OWNED BY MBS.  
COPY OR REPRODUCTION IS FORBIDDEN  
WITHOUT PREVIOUS NOTICE

SCALE	DESIGNED	DRAWN	CHECKED	SHEET 4 OF 4	FORMAT
DATE	.	.	NOV-09	NAME	EUR
SIGNATURE	P.GLEZ	.	J.SAURA		A3
NAME	<b>PARIS CLASSIC COVER (GENERAL VIEW)</b>			DRAWING NUMBER	
				.	
				CAD FILE	
				PARIS CLASSIC COVER MBS.dft	